



# Moas Modular Aluminum System SA de CV

## 17-052 Tuerca plana 45, rosca M6



### Características

Tuerca plana para perfil de 45x45 mm mod 14-040, ranura 10 mm, con rosca M6. La tuerca accede únicamente desde el extremo abierto del perfil. Excelente fuerza de agarre.

### Especificaciones

**Material:** Acero al carbón, galvanizado.

### Imagen:

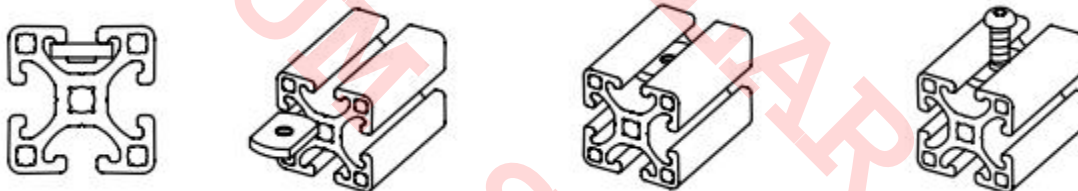
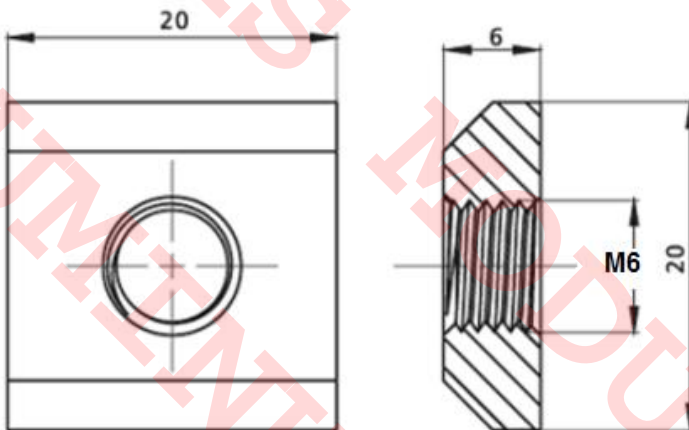
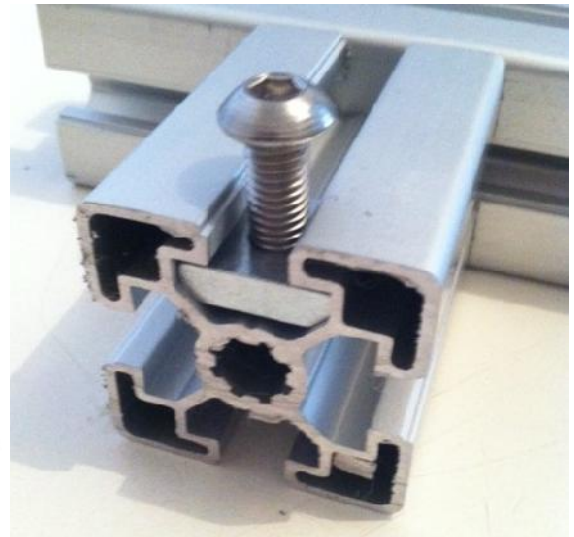

### Forma de Ordenar

**17-052 Tuerca plana 45, ranura 10 mm, rosca M6 para perfil de 45x45 mm std**

### Moas Modular Aluminum System, SA de CV

Tule No. 24 Local A y B, Tlalnepantla Mexico CP 54080

Tel oficina (55) 5362 4016 Almacen (55) 4993 9413 Cel. 04455 3733 0934

[www.moastienda.com.mx](http://www.moastienda.com.mx)

[www.perfilesdealuminioranurado.com.mx](http://www.perfilesdealuminioranurado.com.mx)